

# HT SERIES

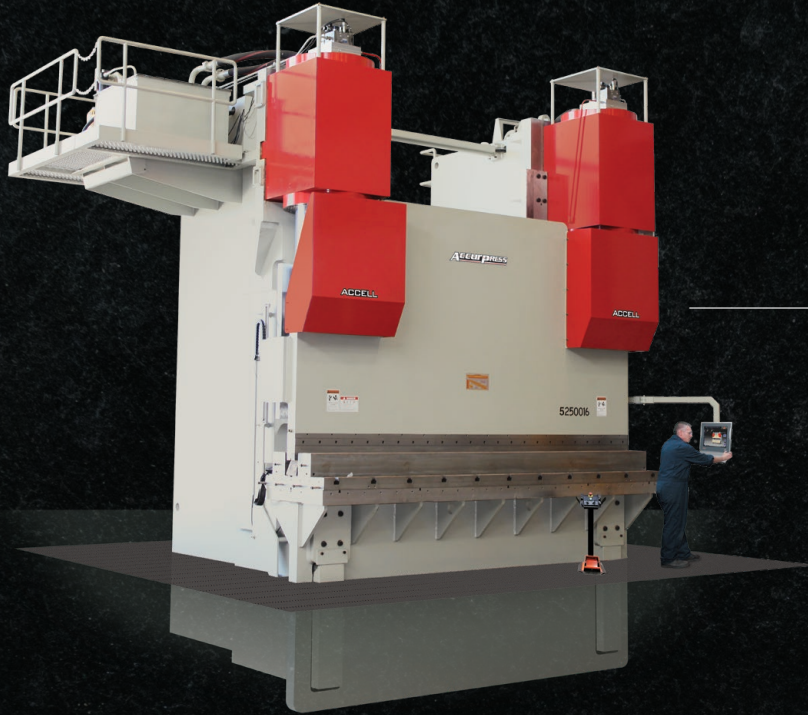

Accell HT

HIGH TONNAGE MODELS

ROCKER HT

HIGH TONNAGE MODELS

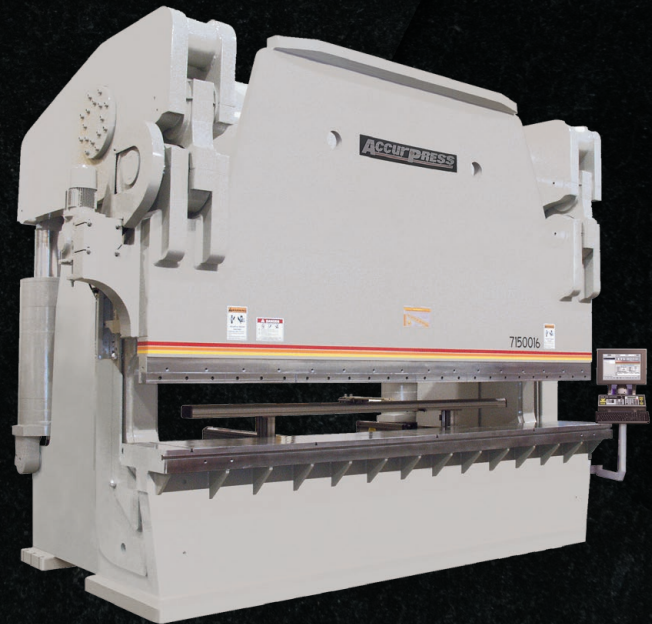

**ACCURPRESS**

HIGH TONNAGE CUSTOM PRESS BRAKES

ACCURPRESS

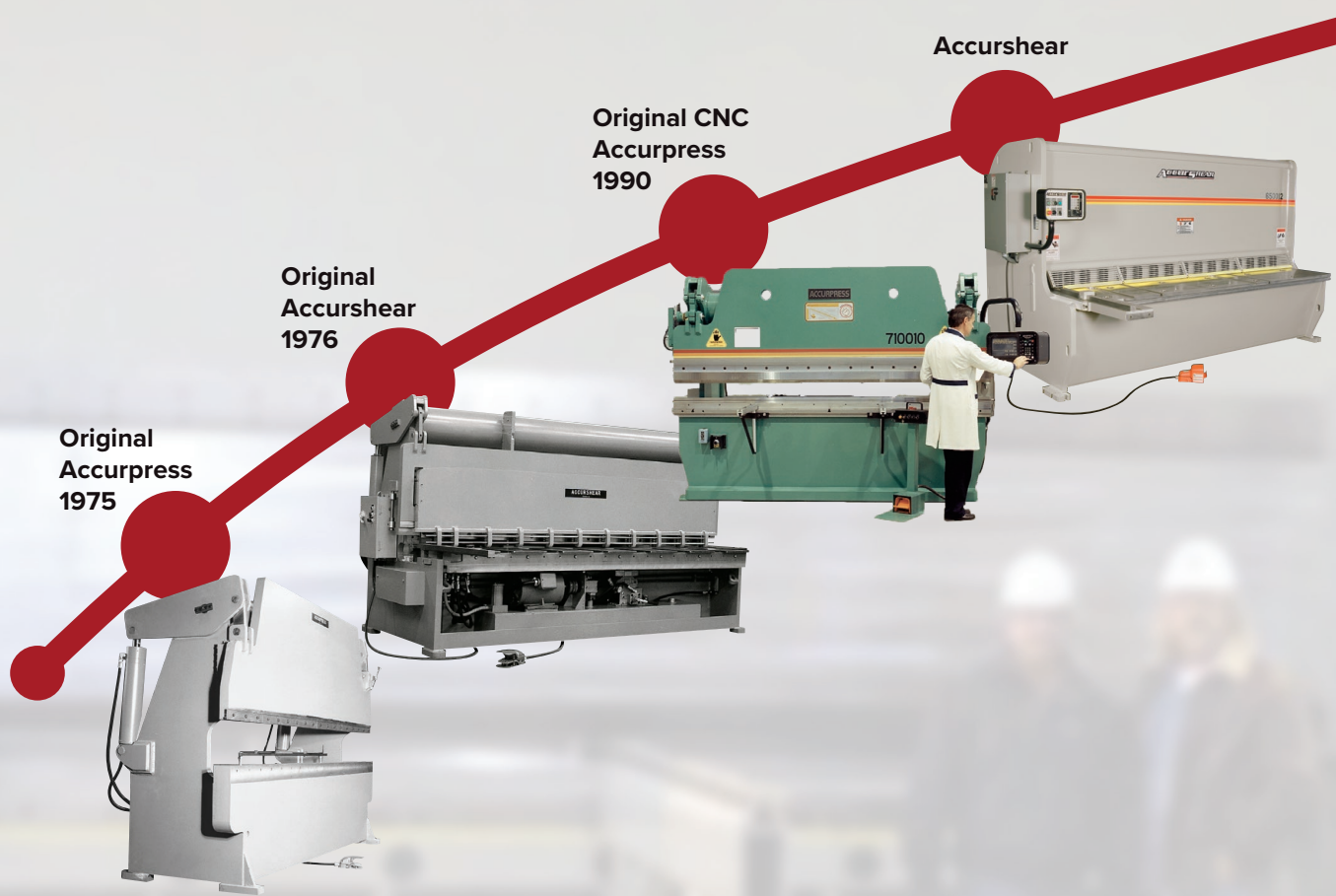

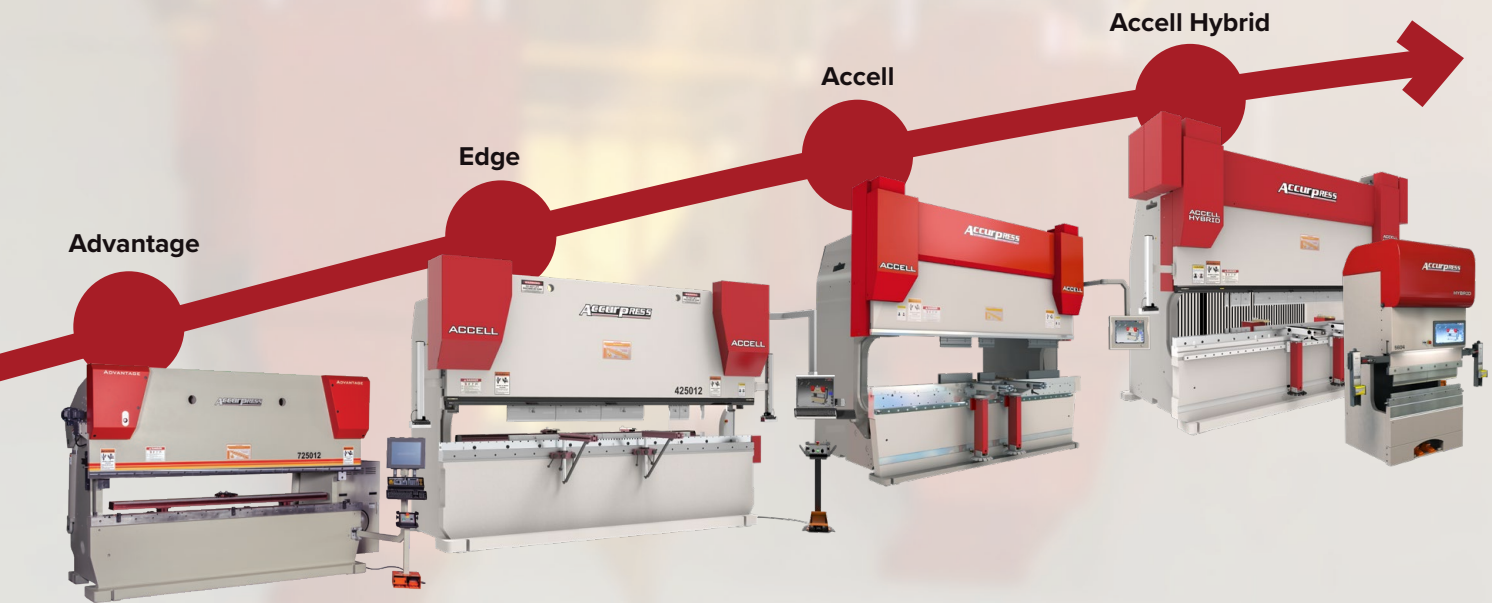

## About Us

With over 45 years in the marketplace, Accurpress continues to build on its tested history to manufacture an innovative and complete line of press brakes and shears for every bending and shearing application. Proudly North American made, Accurpress leads the way with high tonnage machines, revolutionary pole bending technologies, tandem machines, and robot automation. With over 21,000 machines sold to thousands of satisfied customers, Accurpress continues to build press brakes and shears to meet the demands of today's manufacturing environments.

"While 45 years have brought huge changes to the machine tool industry, all of us at Accurpress continues to stand firm on the original foundation of quality that the company was built on. Every Accurpress machine, including the one you'll buy, is made with 100% of our best efforts. Our business depends on it and so does yours."

**Steve Hilton**  
President

## The **ACCURPRESS HT** Lineup

### ROCKER HT

HIGH TONNAGE MODELS From 600-2100 Tons

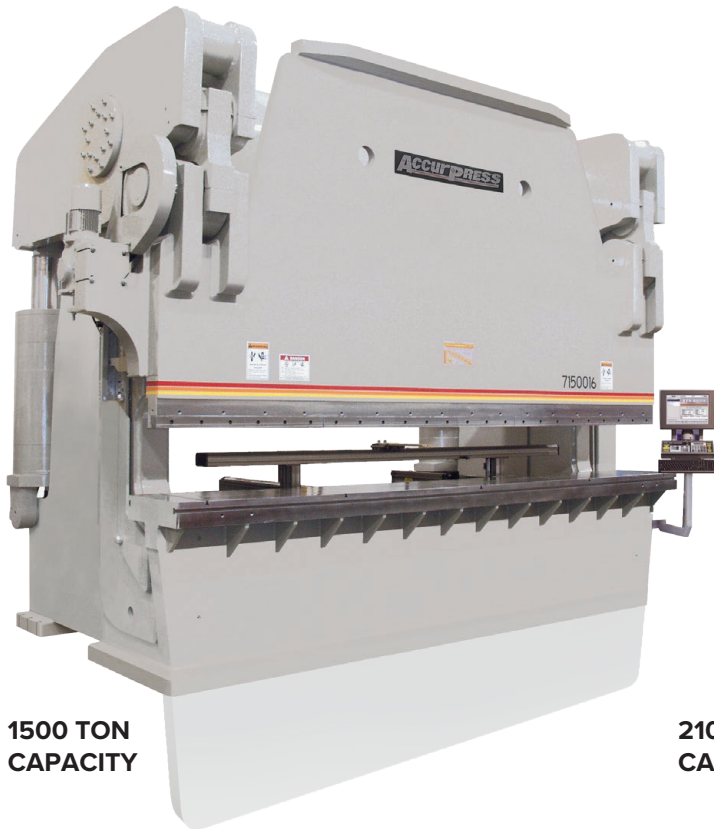

**1500 TON  
CAPACITY**

The **Accurpress Rocker** design stretches back to the 1970's and has stood the test of time in a multitude of heavy fabrication shops while offering long term dependability and forming accuracies.

Accurpress offers very high concentrated load ratings on custom machines such as this 2100 ton capacity machine below.

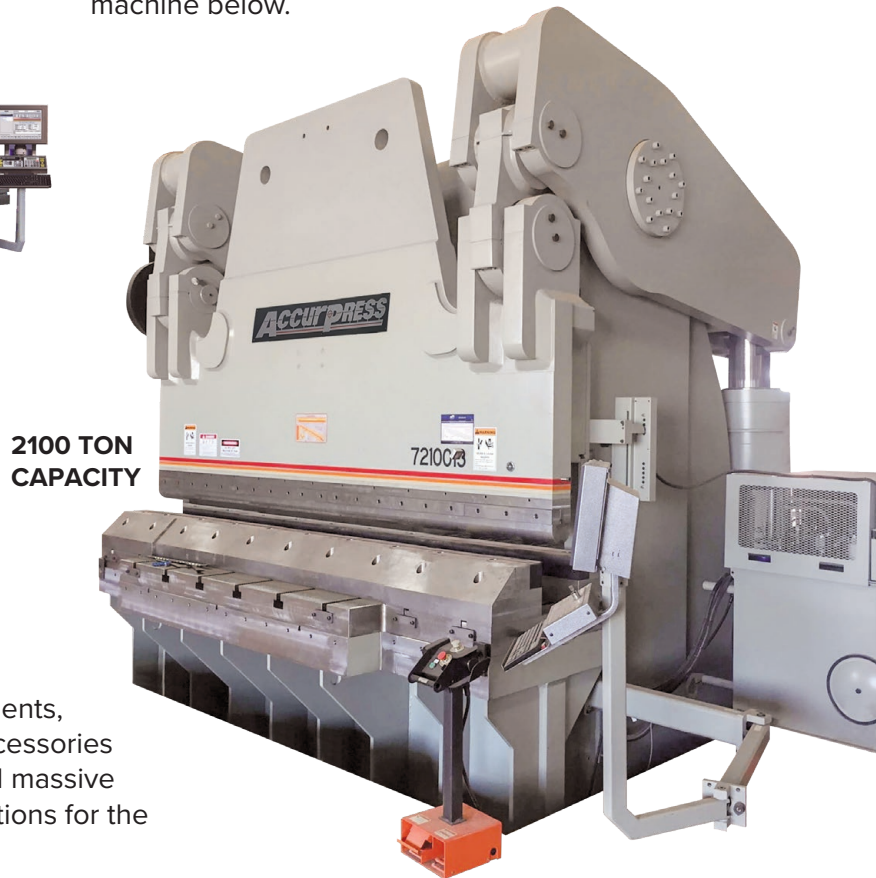

**2100 TON  
CAPACITY**

To satisfy the endless variation of bending requirements, we offer a wide selection of heavy-duty optional accessories such as Titan Gauging, Sheet Follower Systems and massive Upper and Lower Dies to provide the optimum solutions for the biggest forming jobs.

# ACCELL HT

HIGH TONNAGE MODELS From 650-3000 Tons

The Accurpress Accell-HT offers the best solution for jobs requiring maximum ram stroke length flexibility.

**2000 TON CAPACITY**

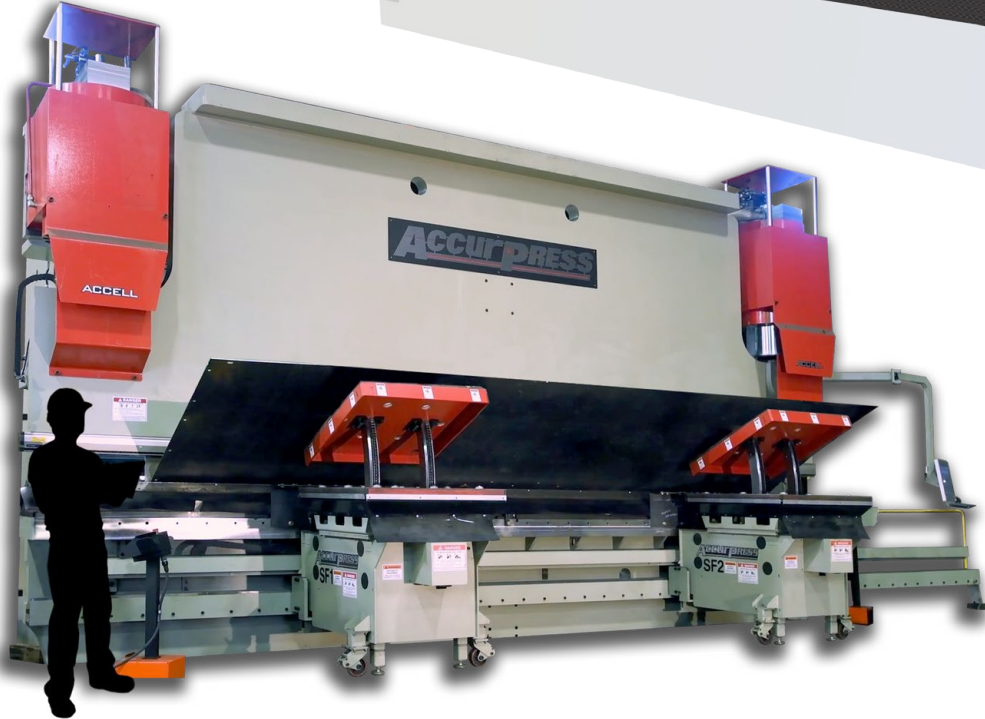

The Accurpress Accell, with its rugged builds and numerous optional accessories, are built to stand up to any advanced forming challenge over decades of usage.

**1250 TON CAPACITY**

## The Accurpress **ROCKER HT** Lineup

### 600-2100 Ton Models

The Accurpress Rocker-HT has an exceptional track record which is a testament to the reliability of the Rocker design over many decades of operation!

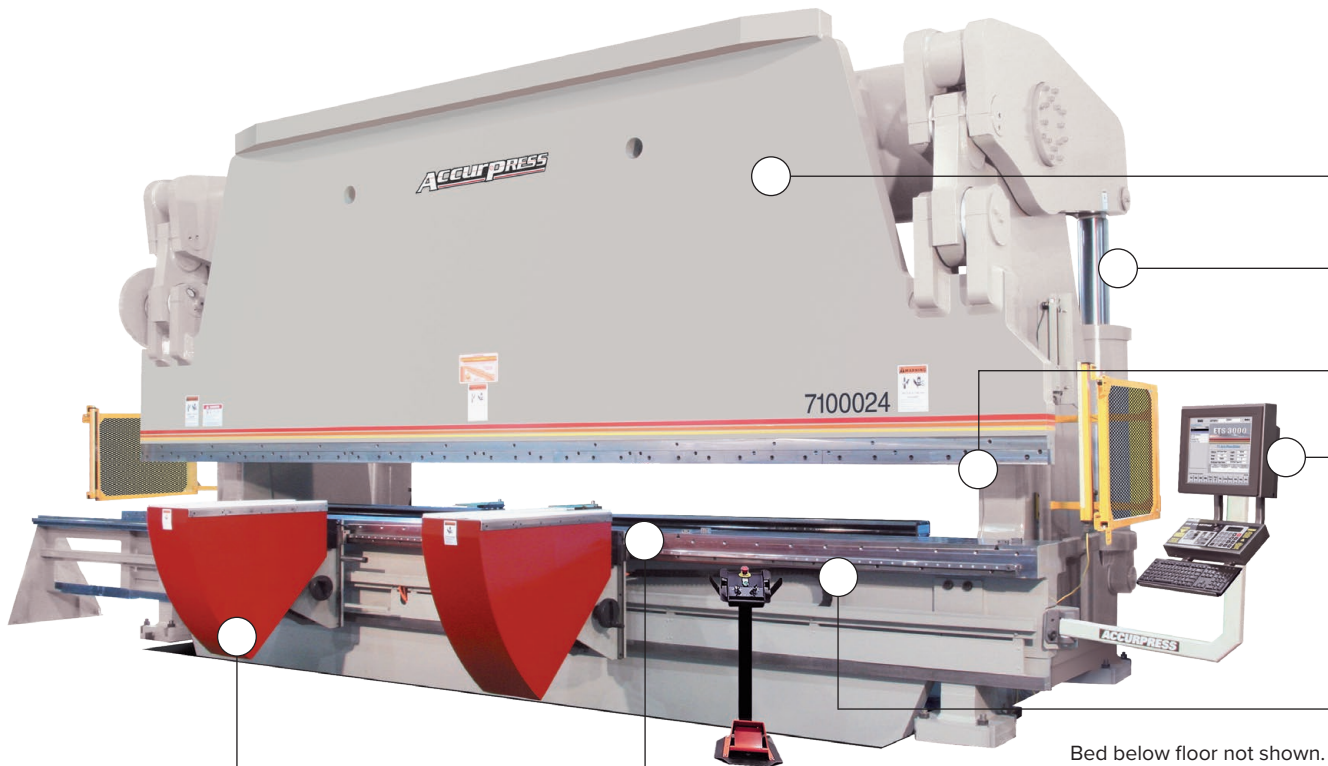

### OPTIONAL SHEET FOLLOWERS

The Accurpress Sheet Following System incorporates a movable table that lifts and supports material during the bending motion. It is fully synchronized with the ram bend speed and desired angle and can support a load capacity of 500lbs per Sheet Follower. Descent speed and activation of the Sheet Following System are fully programmable by the operator.

## **MACHINE DESIGN**

The engineering design of the Accurpress Rocker is built with cylinders mounted at the back of side frames and attached to a pair of heavy-duty rocker arms, and has proven itself in thousands of fabrication shops throughout North America since the mid 1970's. Constructed with quality components from leading suppliers throughout the world, including maintenance free, self-aligning spherical bearings suited for high tonnage loads and oscillating motion—has all resulted in a press brake built for the long haul.

## **RAM TOOL CLAMPING SYSTEMS**

The Press Brake Ram is manufactured with Hardened Clamp Bars to withstand the vigorous demands of heavy plate forming. Optional Hydraulic Clamping Systems are also offered to provide maximum efficiency specific to the required application.

## **CUSTOM BUILT**

Accurpress builds Press Brakes to meet and satisfy the strict demands of special forming jobs. We offer customized Ram/Bed Horn Extensions, Increased Ram Open Heights, Structural Modifications and a wide selection of optional accessories.

## **ETS3000 CONTROL**

The Accurpress Rocker-HT models operate via the robust ETS3000 control, developed and supported by Accurpress.

## **SPECIALIZED TOOLING OPTIONS**

The Ram is manufactured with Hardened Clamps or can be machined to accept optional Hydraulic Clamping Systems.

## **TITAN BACKGAUGE**

The Titan is the world's strongest backgauge! It has been designed by Accurpress to withstand the highest shock loads from heavy material like no other gauge can do. Offering up to 6-axes in X1/X2, R1/R2, Z1/Z2.

# Accurpress **ROCKER HT** Specifications

MODEL NUMBER	TONS	BED HEIGHT	TOP BED WIDTH	BED DEPTH BELOW FLOOR	RAM OPEN HEIGHT	RAM CLOSED HEIGHT	STROKE LENGTH	OVERALL DIMENSIONS (INCHES)						APPROX. SPEEDS (IN/MIN)			CYCLES PER MIN		APPROX. MOTOR HP	APPROX. SHIPPING WEIGHT (LB)
								A	B	C	D	E	F	APPROACH	BEND	RETURN	STANDARD	HI-SPEED		
760014	600	38	12	—	20	8	12	168	132	202	12	80	126	50	14	80	8	11.5	50	67,000
760016	600	36	12	10	20	8	12	192	156	226	12	80	130	50	14	80	8	11.5	50	71,000
760020	600	36	12	50	20	8	12	240	198	274	12	80	140	50	14	80	8	11.5	50	90,000
760024	600	36	12	55	20	8	12	288	246	322	12	80	154	50	14	80	8	11.5	50	99,000
775014	750	36	12	10	20	8	12	168	126	202	12	82	130	50	14	80	8	11.5	60	73,000
775016	750	36	12	46	20	8	12	192	150	226	12	82	131	50	14	80	8	11.5	60	79,000
775020	750	36	12	56	20	8	12	240	198	274	12	82	141	50	14	80	8	11.5	60	104,000
775024	750	36	12	66	20	8	12	288	246	322	12	82	154	50	14	80	8	11.5	60	114,000
7100014	1000	38	12	40	22	8	14	168	126	202	14	82	150	40	9	65	5	7.5	60	94,000
7100016	1000	38	12	50	22	8	14	192	150	226	14	106	158	40	9	65	5	7.5	60	112,000
7100020	1000	38	12	60	22	8	14	240	198	274	14	106	164	40	9	65	5	7.5	60	124,000
7100024	1000	38	12	72	22	8	14	288	246	322	14	106	170	40	9	60	5	7.5	60	140,000
7125014	1250	38	12	50	22	8	14	168	126	202	14	114	168	40	9	60	4.5	6.5	75	120,000
7125016	1250	38	12	60	22	8	14	192	150	226	14	114	174	40	9	60	4.5	6.5	75	140,000
7125020	1250	38	12	72	22	8	14	240	198	274	14	114	180	40	9	60	4.5	6.5	75	170,000
7125024	1250	38	12	80	22	8	14	288	246	322	14	114	188	40	9	60	4.5	6.5	75	180,000
7150014	1500	38	12	72	22	8	14	168	126	202	14	120	178	37	9	58	4.5	6.5	75	140,000
7150016	1500	38	*	82	22	8	14	192	150	226	14	120	184	37	9	58	4.5	6.5	75	160,000
7150020	1500	38	*	80	22	8	14	240	198	274	14	120	185	37	9	58	4.5	6.5	75	200,000
7150024	1500	38	*	88	22	8	14	288	246	322	14	120	190	37	9	58	4.5	6.5	75	230,000
7210013	2100	*	*	*	26	12	14	168	126	174	22	156	184	*	*	*	*	*	75	175,000
7210016	2100	*	*	*	26	12	14	192	150	226	22	156	*	*	*	*	*	*	75	200,000
7210020	2100	*	*	*	26	12	14	240	198	274	22	156	*	*	*	*	*	*	75	240,000
7210024	2100	*	*	*	26	12	14	288	246	322	22	156	*	*	*	*	*	*	75	280,000

Specifications are subject to change without notice. Consult factory for specifications for machines over 1500 tons.  
 \*Dimensions and specifications available upon request.

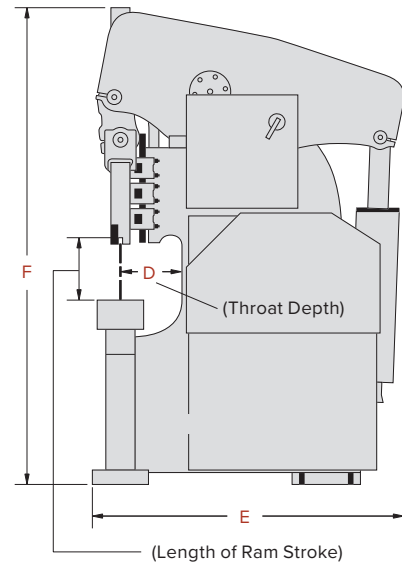
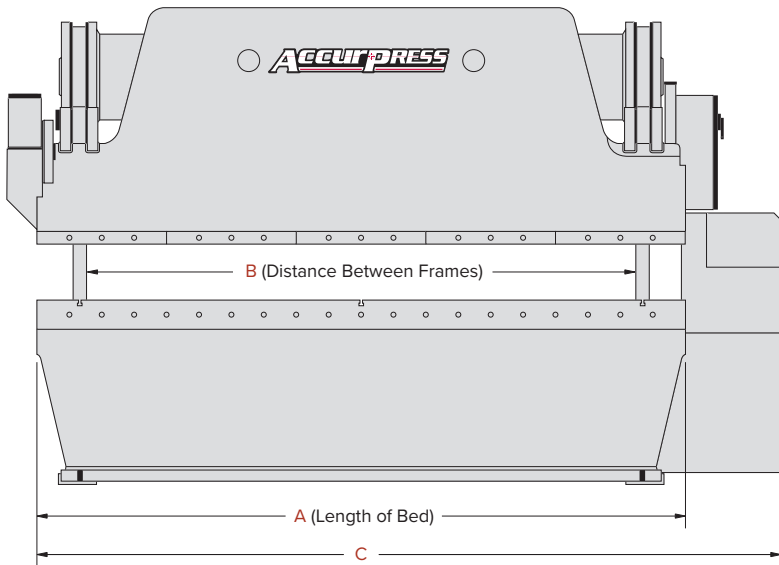





Bed below floor not shown.

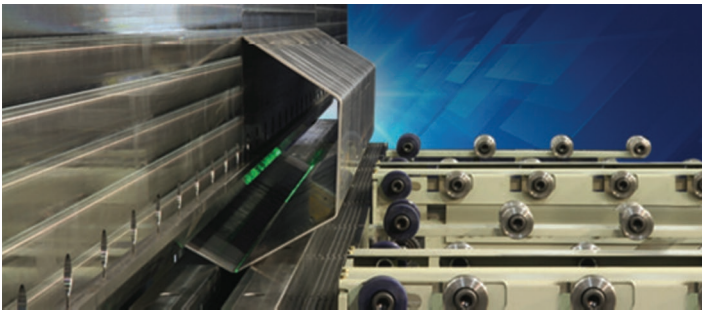

The Accurpress Rocker-HT has found its way into a multitude of shops doing a wide variation of forming jobs, such as this 750-ton X 24-foot machine built with a massive open/closed height configuration utilized in the forming of poles. Specialized tooling was produced by Accurpress along with the heavy duty Frontgauge System to automate the process.

## The Accurpress **ACCELL HT** Lineup

### 650-3000 Ton Models

The standard features of the Accell-HT combine technology and efficient material handling options to make big jobs easier to accomplish. All aspects of our High Tonnage machines are designed to be reliable, flexible and perform in the most demanding conditions.

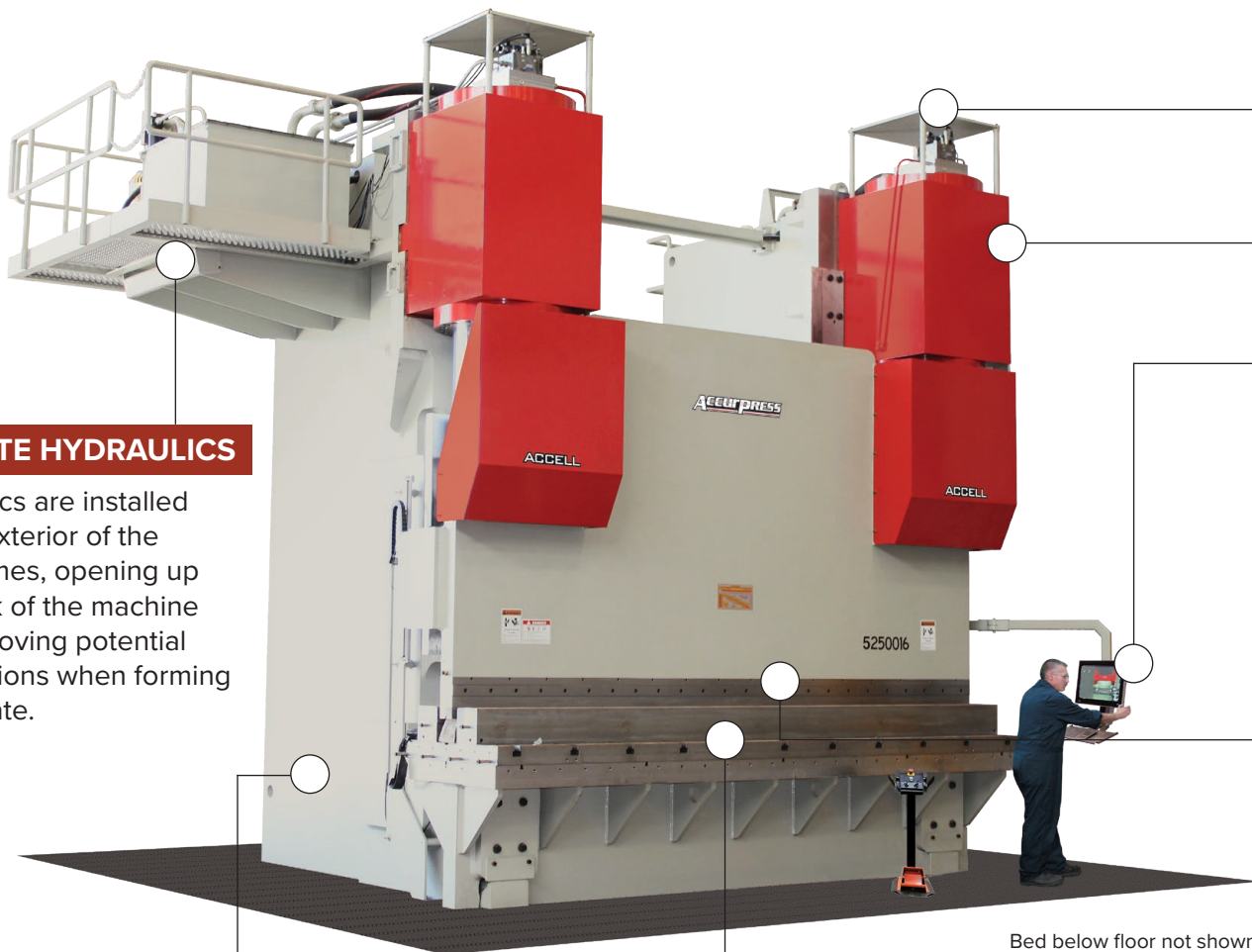

#### REMOTE HYDRAULICS

Hydraulics are installed on the exterior of the side frames, opening up the back of the machine and removing potential obstructions when forming large plate.

#### TITAN BACKGAUGE

[ See P. 17 ]

The Titan is the world's strongest backgauge! It has been designed by Accurpress to withstand the highest shock loads from heavy material like no other gauge can do. Offering up to 6-axes in X1/X2, R1/R2, Z1/Z2 for Accell-HT models.

## **MACHINE DESIGN**

The Accurpress Accell-HT is engineered with the most advanced Y1/Y2 proportional hydraulic technologies to ensure positional accuracies of +/-0.0004, all monitored via a Safety PLC.

## **CUSTOM BUILT [ See P. 16 ]**

Special applications for forming large plate sections may require excessive Ram Stroke and Open Height configurations. The Accell-HT line comes standard with generous Stroke and Ram Heights as well as the flexibility for increased optional length and height requirements. Accurpress will engineer the Accell-HT with structural modifications to support massive tooling applications and/or additional requirements to ensure all factors are addressed in order to provide the best possible press brake solution for special jobs.

## **VISION CONTROL [ See P. 14-15 ]**

The powerful and advanced Vision Control is a standard feature with the Accell-HT models. Numerous features including automatic bend sequencing, tool selection, teach crowning features, 3D offline packages and ease of programming for custom tools provides for the most streamlined part processing software in the industry.

## **RAM TOOL CLAMPING SYSTEMS [ See P. 20 ]**

The Press Brake Ram is manufactured with Hardened Clamp Bars to withstand the vigorous demands of heavy plate forming. Optional Hydraulic Clamping Systems are also offered to provide maximum efficiency as each application and required tooling selections will determine.

## **SPECIALIZED TOOLING OPTIONS [ See P. 20-21 ]**

Accurpress offers an endless selection of Adjustable Channel-lock Tooling options in any and all required die openings, as well as specialized massive Customized Tooling Systems to satisfy the most complicated bending requirements.

# Accurpress **ACCELL HT** Specifications

MODEL NUMBER	TONS	BED HEIGHT	TOP BED WIDTH	RAM OPEN HEIGHT	RAM CLOSED HEIGHT	STROKE LENGTH	OVERALL DIMENSIONS (INCHES)						APPROX. SPEEDS (IN/MIN)			APPROX. SHIPPING WEIGHT (LB)
							A	B	C	D	E	F	APPROACH	BEND	RETURN	
565014	650	38	12	24	10	14	168	145	192	20	100	154	260	24	200	77,000
565016	650	38	12	24	10	14	192	168	216	20	100	154	260	24	200	85,000
565020	650	38	12	24	10	14	240	216	264	20	100	154	260	24	200	110,000
565024	650	38	12	24	10	14	288	264	312	20	100	154	260	24	200	132,000
585016	850	38	12	24	10	14	192	164	216	20	104	164	240	20	160	101,000
585020	850	38	12	24	10	14	240	212	264	20	104	164	240	20	160	121,000
585024	850	38	12	24	10	14	288	260	312	20	104	164	240	20	160	138,000
5100016	1000	38	12	24	10	14	192	164	216	20	108	174	160	20	120	120,000
5100020	1000	38	12	24	10	14	240	212	264	20	108	174	160	20	120	138,000
5100024	1000	38	12	24	10	14	288	260	312	20	108	174	160	20	120	156,000
5125016	1250	38	12	28	10	18	192	153	216	20	114	178	100	12	100	128,000
5125020	1250	38	12	28	10	18	240	201	264	20	114	178	100	12	100	152,000
5125024	1250	38	12	28	10	18	288	249	312	20	114	178	100	12	100	172,000
5125030	1250	38	12	28	10	18	360	321	384	20	114	178	100	12	100	240,000
5150016	1500	38	12	28	10	18	192	150	216	20	120	182	100	12	100	135,000
5150020	1500	38	12	28	10	18	240	198	264	20	120	182	100	12	100	170,000
5150024	1500	38	12	28	10	18	288	244	312	20	120	182	100	12	100	190,000
5150030	1500	38	12	28	10	18	360	318	384	20	120	182	100	12	100	260,000
5200016	2000	38	*	34	10	24	192	146	216	22	126	*	90	10	90	175,000
5200020	2000	38	*	34	10	24	240	194	264	22	126	*	90	10	90	200,000
5200024	2000	38	*	34	10	24	288	242	312	22	126	*	90	10	90	235,000
5200030	2000	38	*	34	10	24	360	314	384	22	126	*	90	10	90	308,000
5250024	2500	38	*	34	10	24	288	236	*	22	*	*	*	*	*	310,000
5250030	2500	38	*	34	10	24	360	308	*	22	*	*	*	*	*	390,000
5300024	3000	38	*	34	10	24	288	230	*	22	*	*	*	*	*	390,000
5300030	3000	38	*	34	10	24	360	302	*	22	*	*	*	*	*	450,000

All Accell-HT machines require below floor level bed. Specification may not be exact & are subject to change.  
 Machine shipping widths & weight may change pending optional accessories  
 \*Dimensions and specifications available upon request.

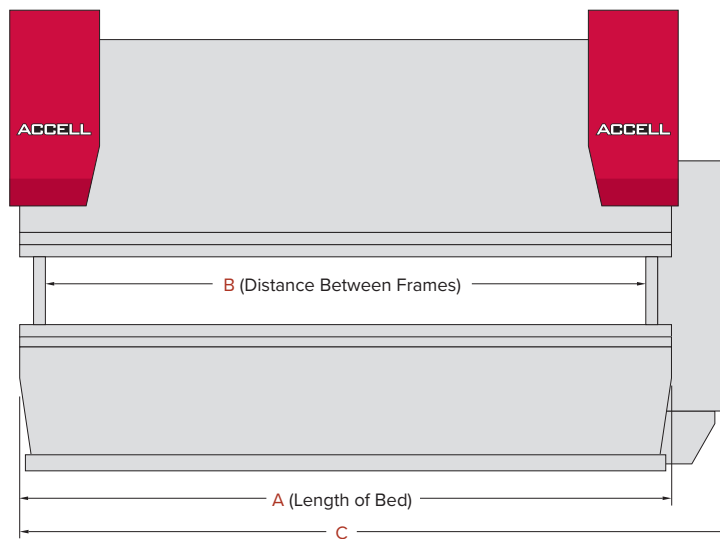
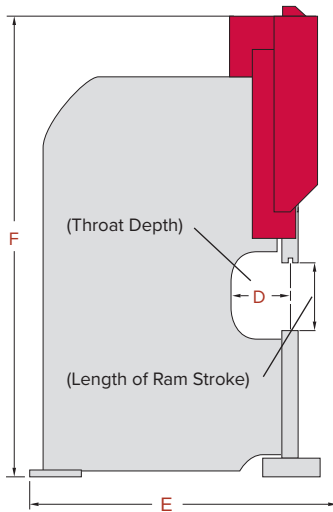

**Accurpress has the experience and reputation of building hundreds of High Tonnage machines, located all across North America.**



Accurpress Tandem 1500 ton by 30 ft press brakes forming 60 ft custom poles.

**NO JOB IS TOO BIG FOR ACCURPRESS!**

## VISION Control

The Vision Control is a ground-breaking and revolutionary press brake control software system. Vision streamlines and simplifies the bending process, giving you full control over every aspect of metal forming.



### FEATURES

- Touch screen control
- Automatic bend sequencing
- Automatic tool selection
- Quick tooling change
- Complete control over all axis
- Simple bump bending
- Special bend support such as offset, hemming and pre-bends
- Easily program custom tools
- Teach crowning features



Sketch part profile using touchscreen

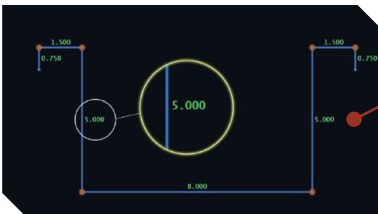

Easily add dimensions and angles



Confirm bend sequence and tooling

Begin forming

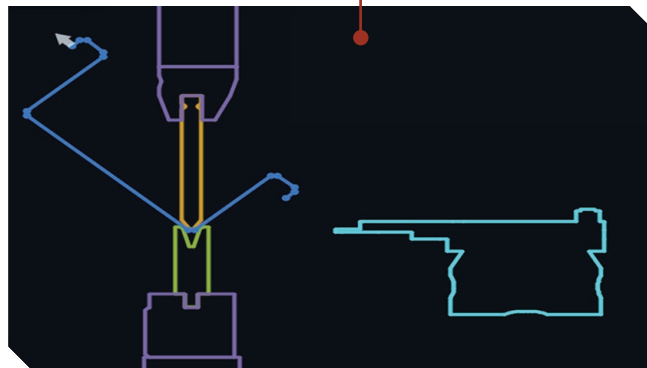



# VISION 3D

Working with Solidworks or Inventor, Vision 3D lets you import part models into Vision for full 3D programming, bend visualization and dynamic viewing during the forming process.

## Use **VISION** in your part models

### FEATURES

• Accurate Bend Radius

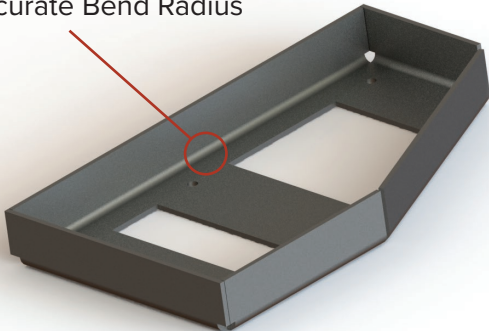

• Accurate Flat Patterns

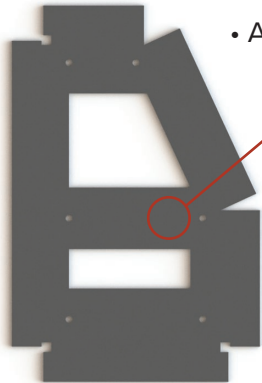

• Dynamic 3D Bend Simulation

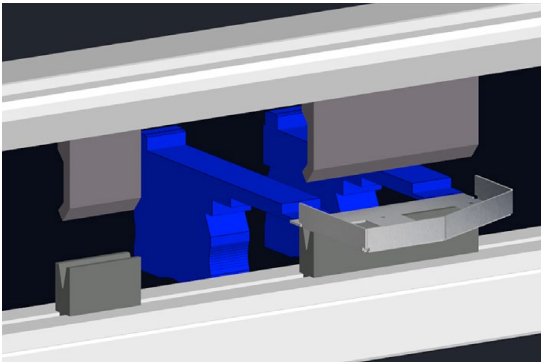

• Run 3D programs on the ETS3000



## BACKGAUGE Options

### SUPREME Backgauge

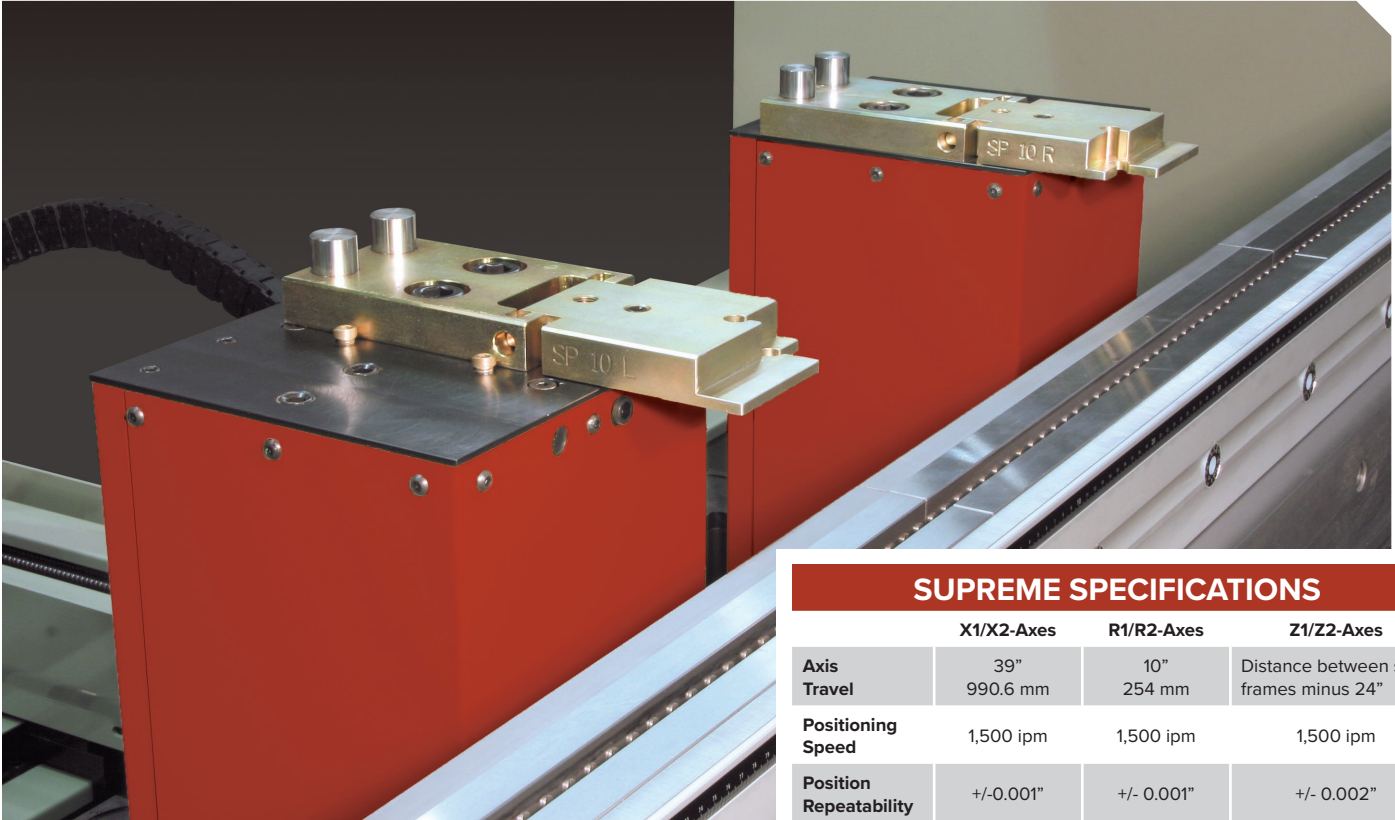

SUPREME SPECIFICATIONS			
	X1/X2-Axes	R1/R2-Axes	Z1/Z2-Axes
Axis Travel	39" 990.6 mm	10" 254 mm	Distance between side frames minus 24"
Positioning Speed	1,500 ipm	1,500 ipm	1,500 ipm
Position Repeatability	+/-0.001"	+/- 0.001"	+/- 0.002"
Holding Force	1,700 lbf X2 X-Axis Drives		

For applications demanding the most complex sheet metal parts and in high productions shops, Accurpress offers the Supreme backgauge available for the Accell-U models. Constructed from a one-piece rugged steel platform that is isolated from the press brake ram movements, the Supreme backgauge is built for optimum accuracy, high speeds on all 6-axes (X1/X2, R1/R2, Z1/Z2) and for years of minimal service requirements. Included with the Supreme backgauge is a rear gate attached to the back of the Accell-U inclusive of a safety interlock switch to meet all applicable safety standards.

To ensure compliance to applicable safety standards, Accurpress installs rear guarding inclusive of a gate with a safety interlock switch on all Accurpress models sold with the Supreme Backgauge.



# TITAN Backgauge

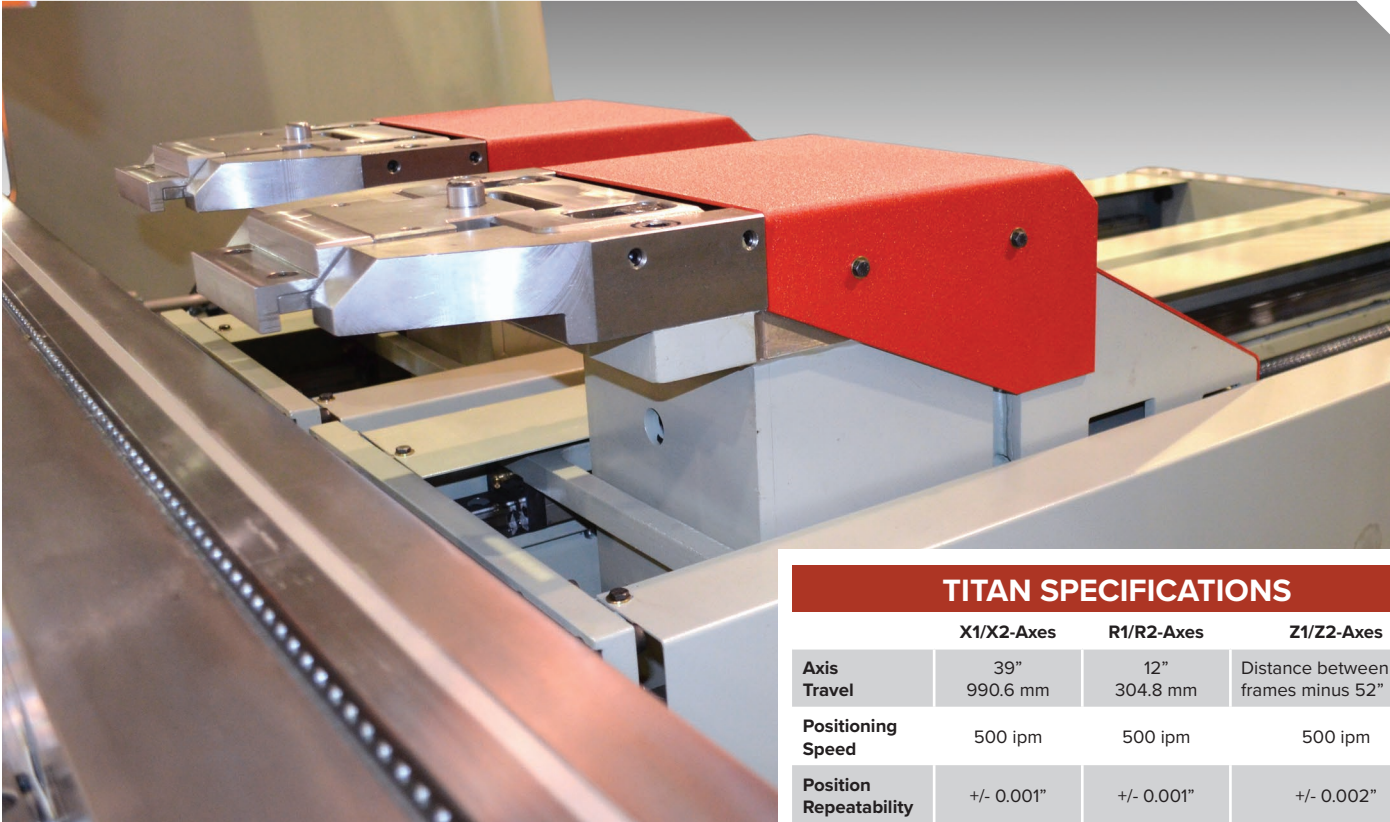

TITAN SPECIFICATIONS			
	X1/X2-Axes	R1/R2-Axes	Z1/Z2-Axes
Axis Travel	39" 990.6 mm	12" 304.8 mm	Distance between side frames minus 52"
Positioning Speed	500 ipm	500 ipm	500 ipm
Position Repeatability	+/- 0.001"	+/- 0.001"	+/- 0.002"
Holding Force	5,000 lbf X2 X-Axis Drives		

The Titan 6-Axis (X1/X2, R1/R2, Z1/Z2) is the world’s heaviest and strongest gauge built specifically for larger Accell E and U models that are fabricating the most extreme parts! Each component including the oversized fingers have been engineered to withstand the most extreme conditions, shock loads and massive forces from placement of large plates in preparation for final gauging and forming. This rugged backgauge features servo-drive motors, lifetime lubricated precision linear bearings and an unsurpassed ability to handle the heaviest of structural plate applications.

To ensure compliance to applicable safety standards, Accurpress installs rear guarding inclusive of a gate with a safety interlock switch on all Accurpress models sold with the Titan Backgauge.

## SUPPORT FIXTURES

### FRONT SUPPORT ARMS

The Accurpress Front Support Arms (36" support length) are fully adjustable for different tooling heights and thicknesses. The bottom Foot Disk allows the operator to easily adjust the height of the Support Arm while the top support piece can be adjusted front to back depending on the desired position. These support arms are mounted on a linear rail for smooth and accurate positing left to right on the press brake.

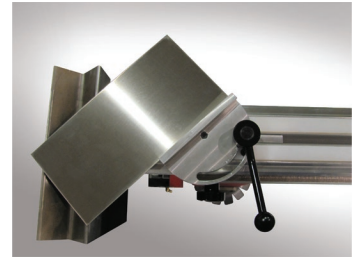

Built in protractor

### SHEET FOLLOWERS

Accurpress offers two Sheet Follower capacities to provide the most efficient and cost-effective options for a variety of applications in the fabrication industry. The Sheet Following System is inclusive of moveable support table(s) that rotate during the bending motion, synchronized with the ram speed and desired angle. The standard design allows for a load capacity of 500lbs per each support table. The Follower(s) are integrated to the Accurpress ETS3000 or Vision Control allowing the machine operator programming options for optimal usage.



### SHEET FOLLOWERS PARKING STATION

Sheet Followers can be moved off to the side when not in use, providing full access of the front of the machine.

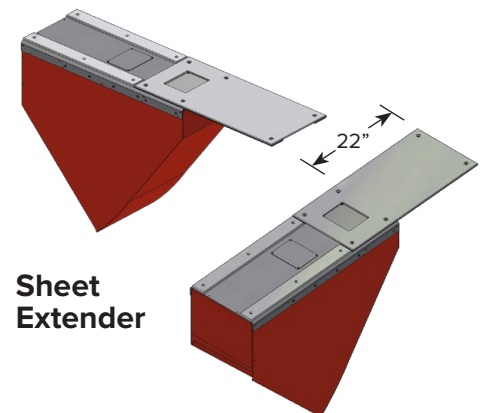
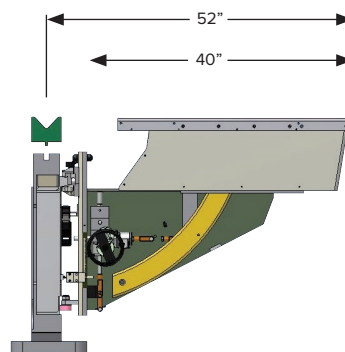

Sheet Extender

## TITAN FOLLOWERS

High tonnage applications will necessitate press brake optional accessories to complement the vigorous demands placed on the equipment. Accurpress has the solutions! The Titan Follower System is manufactured to withstand massive forces in heavy plate fabrication environments. Each table can support a load capacity of 1500lbs synchronized with the ram bend speed and desired angle.



## FEATURES

- Titan Follower(s) may be purchased as a single or dual units
- Titan Follower(s) are fully synchronized with the ram bending speed and bend angles
- Titan Follower(s) are compatible with either the Accurpress ETS3000 or Vision controls
- Load capacity = 1500 lbs. for each table
- Table size: 36-inches wide X 42-inches length
- Table(s) Height (R-axis): 6 inches of travel is manually adjusted or optional CNC is available
- Table(s) Forward-Reverse (X-axis): 7 inches of travel is manually adjusted or optional CNC is available
- Table(s) Left-Right (Z-axis) positioning is accomplished manually by sliding the units on the custom rail on the front of the Accurpress bed

## IMPORTANT

The Accurpress machine configurations including tooling specifics must be confirmed to assure conformity of the Sheet Follower functionality!

## TOOLING Options

Accurpress manufactures an endless variety of tooling that is specifically tailored to meet any and all press brake forming jobs. We will work with you to provide the best solution every time!

### Adjustable Power Lock Dies

The Accurpress Channel-lock Adjustable Power Lock Die offers the most efficient time-saving V-opening positions for large tooling worldwide. It eliminates the enormous amounts of wasted time wrestling large pieces of tooling on/off a press brake. The Accurpress HT models are customized with widened bed caps to facilitate the size of Adjustable Tooling ordered. The units are available in a variety of options and sizes from manual crowning and V-Die openings to full CNC V-Die openings and Power Lock/Unlock.

#### AUTOMATIC V-OPENING ADJUSTMENT

The hydraulic system provides lift to accommodate quick and easy die opening adjustments.

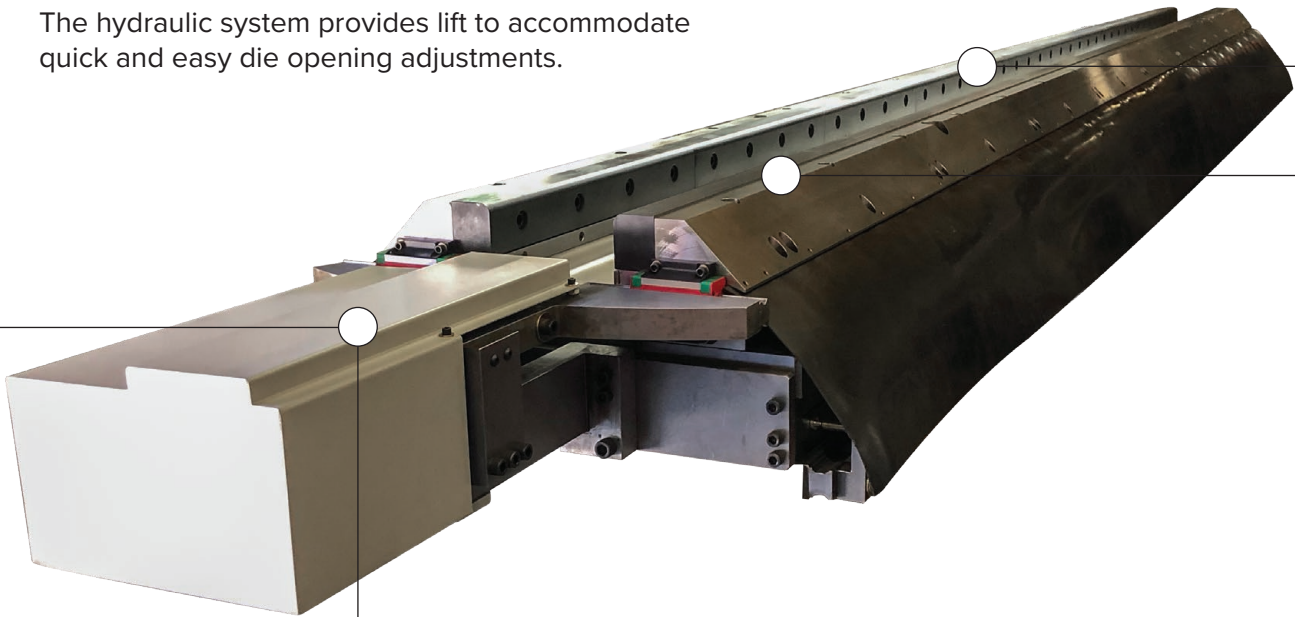

#### CNC FUNCTIONALITY

Adjust V-openings in just seconds via the Vision or ETS3000 Control.



### SPECIAL TOOLING... ALL SIZES AND CONFIGURATIONS

Accurpress Tooling Specialists will define and recommend the best possible solutions for special applications. The Adjustable Die pictured here was manufactured for a High Tonnage Accurpress offering flexibility to open up to 30-inches for heavy plate forming between the side frames of the press brake, and reduced openings for the two ends.

### REPLACEABLE HARDENED INSERTS

The hardened inserts provide extra heavy load capacities and longer tool life. The inserts can be replaced when needed, preserving the unit from excessive wear.

### FORM 90 DEGREES ON ALL V-OPENINGS

Clearance exists in all V-openings to produce 90 degree bends. Larger profiles can be made allowing for openings beyond 14". Special requests can be accommodated.

### PLATE ROLLERS [ Optional ]

The addition of optional plate rollers along the full length of the die allows for easier positioning of the plate and prevents marks in the finished product.

### CROWNING CAPABILITY [ Optional ]

Optimal forming quality and huge time saving measures are available through the optional CNC or Manual Crowning feature.

## OPTIONS To Suit All Forming Jobs



### ADDITIONAL OPEN HEIGHT & STROKE LENGTH

Increased Ram Open Heights and Stroke Lengths may be necessary to accommodate special bending applications. The Accurpress Accell-HT model can be customized with increased RAM Stroke/Open Height configurations to meet any and all necessary requirements for forming and plate removal. Unlike the Accell-HT, the Rocker-HT is not offered with additional Stroke Lengths, but may be ordered with additional Ram Open/Closed Heights.



### RAM CLAMPING SYSTEMS

Accurpress offers ram clamping versatility and best-case solutions to accommodate the wide range of heavy bending – from manually-adjusted hardened mechanical clamp bars to a variation of hydraulic systems. Long standing OEM relationships with Wila or Wilson ensures that hydraulic ram clamping systems are made available for American and New Standard tang-style tooling configurations, including Wila's heavy-duty clamping system to withstand heavier tonnage and concentrated loads. Additionally, Wila offers a robust tooling station attached to the Accurpress to facilitate storage along with a time-saving and organized method of removing and attaching the desired punches and dies.

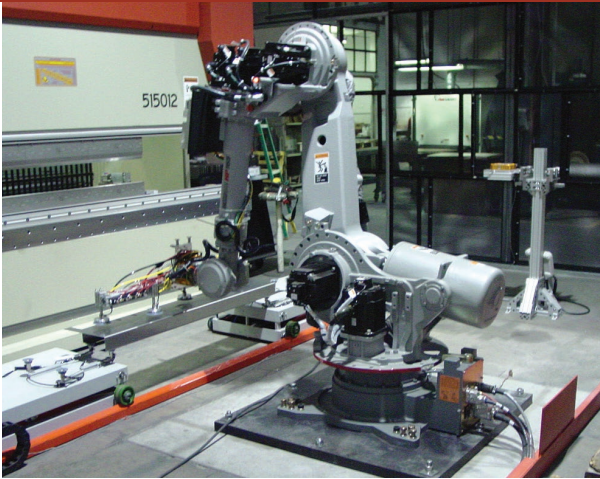

**ROBOTICS INTEGRATION**

Accurpress offers robotics press brake solutions for automated bending. Robotized bending combines the Accell press brake with experienced partners in robotics and offline software.



**TANDEM MODE**

The Accell-HT Models can be installed in Tandem, where two or more machines operate as one. During operation, the machine controls are electronically connected to exchange information for fully synchronized forming. This flexible package offered by Accurpress provides the press brake operator with the luxury of choosing single machine operation or tandem via a simple selector switch.

**INCREASED THROAT DEPTH**

The Accell-HT can be customized to have additional throat depth clearance to facilitate parts with deeper flange lengths.



## POLE BENDING Machines

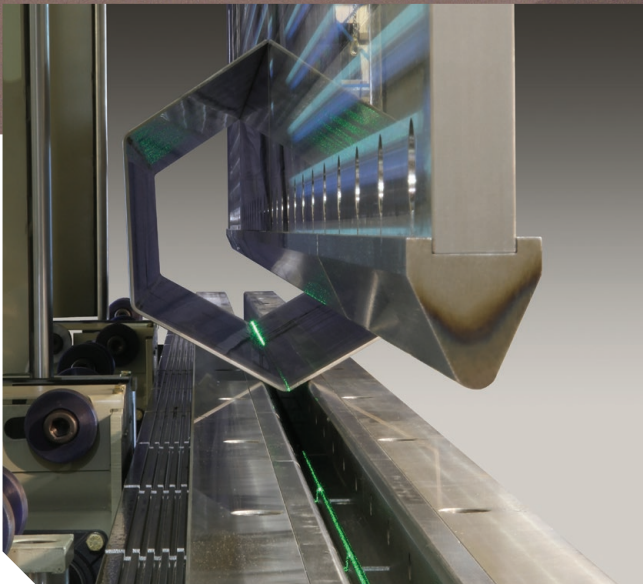
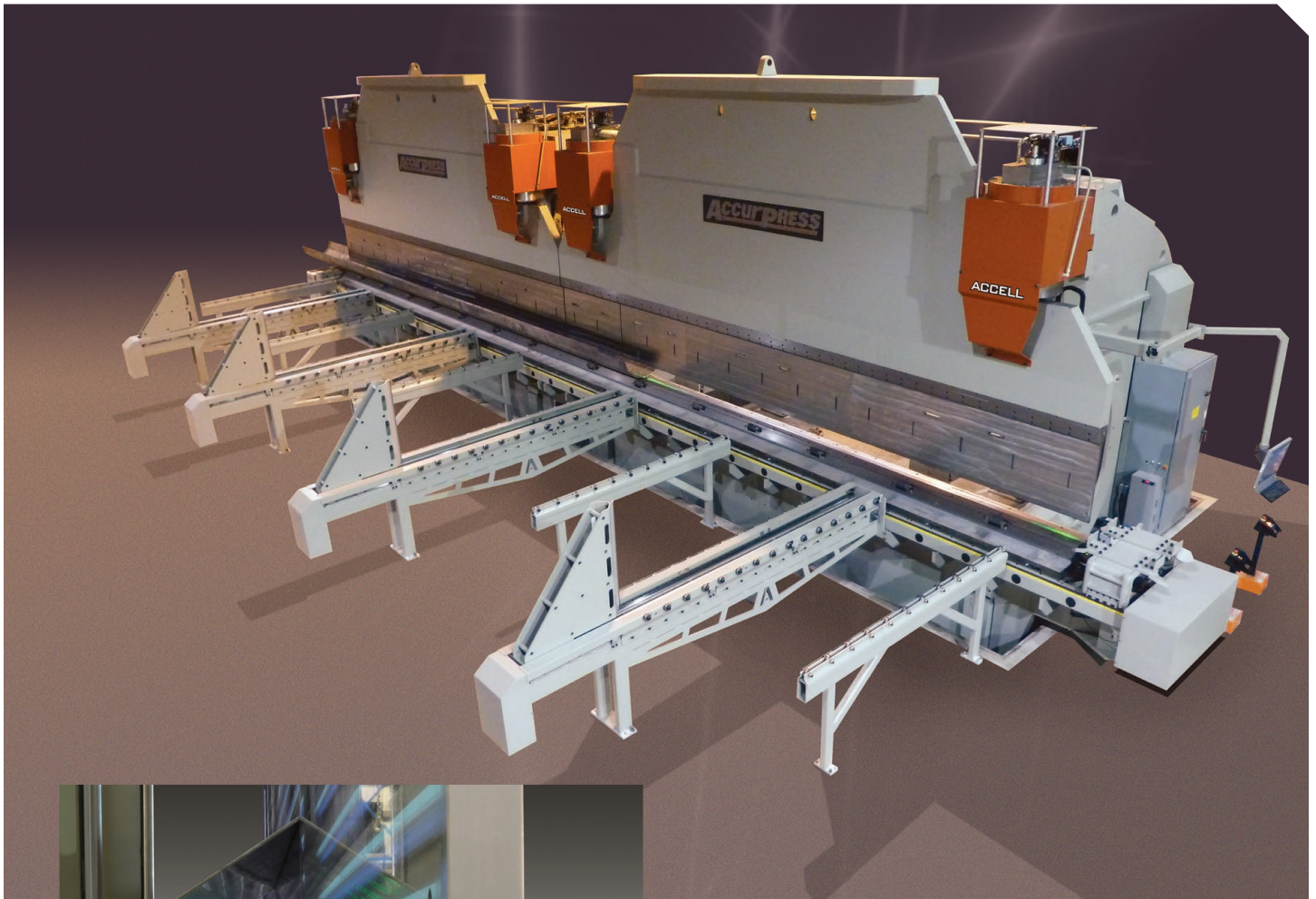

Accurpress has the solutions to meet the unique demands of Pole Bending applications. We will work with you to identify and detail the many requirements, including the machine build, that are essential to ensure the correct configuration for accurately bent poles.



## POLE GAUGING

Accurpress' Pole Gauging system allows for material to be placed on the machine without the need for custom jigs or time consuming part alignment procedures.



- The risers will move forward and sense the material position and orientation.
- Plate position and shape are quickly determined. The gauging system will automatically move the part into position for the first bend.
- Tapered parts and offset gauging are not a problem with this one-of-a-kind gauging system.



## POLE EXTRACTOR

Pole bending machines can be installed with a pole extractor system that will push the finished part off to the side of the machine for ease of handling.

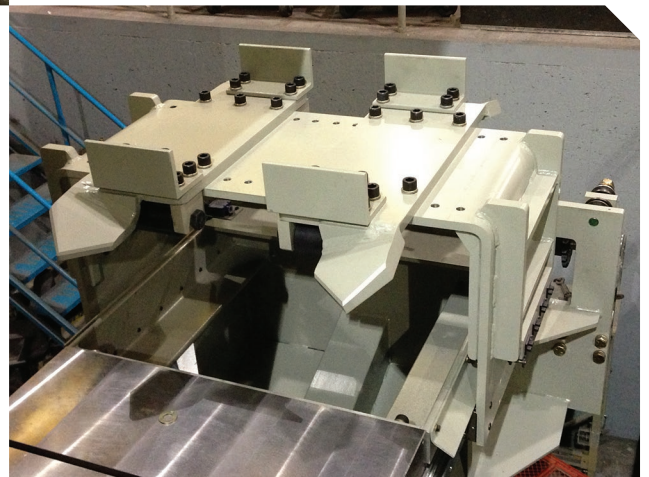

## SAFE GUARDING Systems

### LAZERSAFE SENTINEL

Lazersafe Sentinel is a Safety System offered on the Accurpress HT models that incorporates a continuous dual beam laser field protection zone directly below the punch tip. The Accurpress will immediately stop if any obstruction is detected when the ram is in motion. This system is most efficient up to 32' ram/bed lengths.



### LAZERSAFE SENTINEL PLUS

The Lazersafe Plus includes a dual beam system with a camera as a receiver that recognizes and monitors the silhouette of the punch. The Plus has the added benefit of allowing the ram to operate in fast speeds closer to the pinch point. This system is most efficient up to 18' ram/bed lengths. A Sentinel Plus HL system is available for Accurpress models 20' and longer in length.

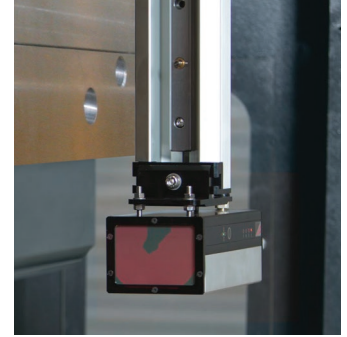

### FISSLER AKAS 3F

The Fessler Laser Guarding System protects the operator from the pinch point hazard of closing tooling. The Fessler system transmits 3 lasers across the tooling area and monitors any interference as the parts are formed. In the event of an unplanned obstruction in the laser area, the ram is immediately stopped, thereby protecting the operator.

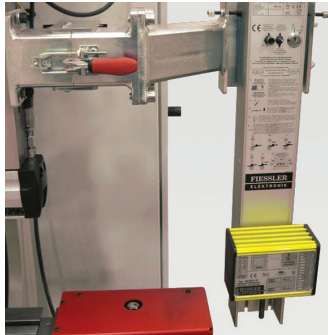

### LIGHT CURTAIN GUARDING

Some applications may be best suited to a Light Curtain Guarding System. Accurpress will work with you to recommend a safety system that will provide a secure working environment.

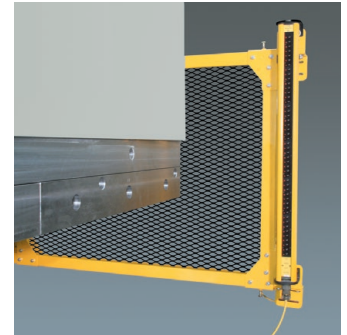

### REAR GUARDING

This is a standard feature for all Accurpress HT models that have an Elite or Titan Backgauge. A metal fixture with a gate and a safety interlock switch is installed and safely blocks operator access to the backgauge area. If the operator needs to access the back of the machine, the interlock switch on the gate will prevent the machine from turning on when the door is opened.



**NO JOB IS TOO BIG FOR ACCURPRESS!**

Contact your local Accurpress Dealership to discuss any length and tonnage press brake requirements.

# DEALER SUPPORT NETWORK

Accurpress Sales & Service is provided by an Authorized Dealer Network. All of our Dealers are factory trained and supported to provide you with knowledgeable competent, and local service



For more information about our products, please refer to our comprehensive brochures or visit our site [www accurpress.com](http://www accurpress.com)

**ACCURPRESS**

PRECISION FORMING SYSTEMS